



WRANGLER JL/JK

ACCESSORIES AND PERFORMANCE PARTS





YOUR JEEP. YOUR ADVENTURE

Rugged Ridge® is synonymous with quality Jeep® parts and accessories. As a brand from OMIX®, an industry leader in Jeep restoration and replacement parts, Rugged Ridge is a household name among Jeep and off road enthusiasts. With over 3,000 products developed and manufactured to date, Rugged Ridge continues to add hundreds of new products each year to satisfy the off road enthusiast's desire to personalize their Jeep. Over the past ten years, Rugged Ridge has developed many unique and patented items that set us apart from other manufacturers in the market. Items like the Modular XHD bumpers, modular snorkel, X-Clamp, Hurricane fender flares are just some of these. Tested and proven by Rugged Ridge's engineering team and employees, you can trust that Rugged Ridge products are the perfect fit for your Jeep.



BUY WITH CONFIDENCE

We take pride in building quality products and back them up with a **minimum 5 Year Limited Warranty** so you can buy with confidence and have peace of mind. For more information on our warranties visit, www.omix-ada.com/warranties.

The Dana® Trademarks referred to herein are Trademarks of Dana Limited. The Dana® Trademarks are used for informational purposes only, and there is no connection between Omix-ADA, Rugged Ridge or Alloy USA and Dana®

Jeep® is a registered trademark of FCA US LLC, Omix-ADA® is not affiliated with FCA US LLC.

A FEW WORDS ABOUT PRODUCT SAFETY

The OMIX®, Rugged Ridge® and Alloy USA® brand products illustrated in this catalog are generally intended to increase the utility and enjoyment of your off-road capable Jeep® or street rod. We hope this catalog will help acquaint you with our featured products as well as the broader offerings in each of our product families. Before installation, please take a moment to review the safety information and installation instructions accompanying your product. Safety information for particular products is summarized in this catalog but is not intended as a substitute for your review and understanding of actual product instructions and warnings! Important safety information is generally preceded by one of three signal words indicating the relative risk of injury. The signal words mean:

⚠ WARNING

A hazardous situation which, if not avoided, could result in death or serious injury. **You can be killed or seriously hurt if you don't follow instructions.**

⚠ CAUTION

A hazardous situation which, if not avoided, could result in minor or moderate injury. **You can be moderately hurt and also may suffer property damage if you don't follow instructions.**

⚠ NOTICE

Careful attention is required to this instruction or operation but does not generally relate to personal injury. **Damage to your product or other property may result if you don't follow instructions in their entirety.**

We hope you enjoy your OMIX®, Rugged Ridge® and Alloy USA® purchases and are here to help if you have questions. See Customer Service contacts included with your Limited Warranty.

ATTN: STATE OF CALIFORNIA CONSUMERS

⚠ **WARNING: Cancer and Reproductive Harm - www.P65Warnings.ca.gov.**

Products in this catalog are subject to California Prop 65.



JL ARCUS™ BUMPERS

The Rugged Ridge Arcus Front Stubby Bumper for Wrangler JL is anything but your typical budget-minded bumper. The Arcus represents a daring design departure from the typical, with an alluring stamped-steel body usually reserved for bumpers costing twice the price. This patented design utilizes a high-strength 11-gauge steel shell surrounding a ¼-inch thick steel winch tray, capable of holding most model winches up to a 12.5k lb. rating (accepts Hawse or roller-style fairleads).

Wrangler JL	Part N ^o
Front Bumper	11549.04

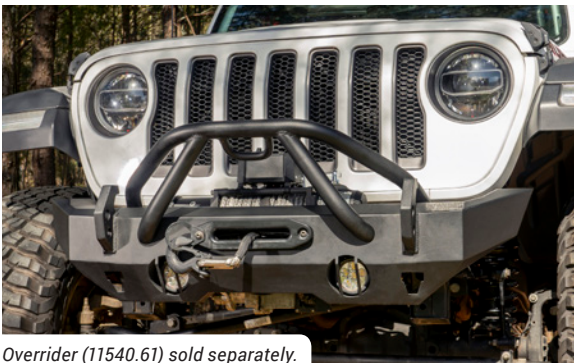

Override (11540.61) sold separately.



Override (11540.62) sold separately.

RUGGED RIDGE HD BUMPERS

Rugged Ridge HD Series Bumpers are trail-tested, proven designs that pack a serious punch. Whether you prefer the narrow, agile angles of our HD Stubby Front Bumper or the burly look of the Full-Width, you will love the aggressive off-road presence they provide. Engineered to mount most any aftermarket winch for greater versatility and well-equipped to perform in the clutch with built-in jack lifting points at every corner and massive recovery hooks, each one dual-drilled to work with both ¾ and 7/8-inch shackles (shackles not included). We've even designed an HD Rear Bumper to go out back, for a highly-functional, total bumper package. Add a beautiful satin black powder coat finish and the confidence of our Limited 5 Year Warranty and the choice becomes clear. Rugged Ridge HD Bumpers are the best-built bumpers in their price class...or any class.



Wrangler JL/JK	Part N ^o
Full-Width Front Bumper	*11540.31
Stubby Front Bumper	11540.32
Rear Bumper	11540.36

*JL Wrangler with Rubicon flares will experience a small gap between the bumper and the flare.



Patent-pending windshield hinge mount keeps mirrors in place regardless of windshield position

TRAIL MIRRORS

Rugged Ridge Trail Mirrors provide a simple, bolt-on solution that is highly-functional, with a clean, modern design that looks great.

Wrangler JL	Part N°
Round	11025.23
Rectangular	11025.24
Round, Pair	11025.25
Rectangular, Pair	11025.26



JL TUBE DOORS

A stylish design that is meant to be seen, not heard. These Rugged Ridge tube doors are free from the dreaded rattling common with other tube doors. Larger diameter tubing, an innovative door latch, and adjustable hinges provide the best looking, best fitting tube door on the market. Patent pending.

Wrangler JL	Part N°
Front, Pair	11509.13
Rear, Pair	11509.14
Front w/ Mirrors	11509.15



LED 3RD BRAKE LIGHT RING

The Third Brake Light LED Ring adds a surprisingly brilliant ring of torch-red LED's behind your spare tire- guaranteed to grab the full attention of all who are near. Patent pending.

Wrangler JL	Part N°
3rd Brake Light Ring	11585.06

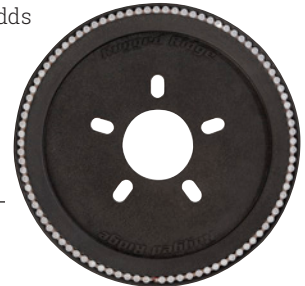

STEEL TUBE FENDER FLARES

Rugged Ridge Tube Fenders were engineered for those die-hard few that love leaving the pavement behind but despise the cringe-worthy sound of tire meeting flare. Outfit your rig to increase your tire clearance, reduce those horrible churning noises and find a whole new unpolished persona.

Wrangler JL	Part N°
Front	11615.71
Rear	11615.72
Front and Rear	11615.73



ALUMINUM INNER FENDER LINERS

Rugged Ridge Aluminum Inner Fenders are a straight-forward and clean way to complete the look of your Wrangler JL without breaking the bank. Crafted from lightweight aluminum plate, brake-formed and engineered for a precise fit making it a direct replacement for the front factory liners.

Wrangler JL	Part N°
Front	11615.61



JL SNORKEL

We engineered the Rugged Ridge Snorkel System for Wrangler JL to be the best option on the market. We started with an aesthetic design inspired by the JL's fender vents, so that it looks more like a natural part of the vehicle. The low-mount intake is the focal part of the system. Also available is our high-mount ram intake. It mounts in minutes and pulls in fresh air from the top of the windshield for confident fording of rivers and streams. We've also designed an optional pre-filter element for use in the dustiest of desert conditions. A convenient manual drain valve at the lowest part of the system allows any negligible water migration to be drained from the system quickly and easily.

Wrangler JL	Part N ^o
Low/High Mount Snorkel System	17756.31
Low Mount	17756.35
High Mount Extension	17756.36
Ram Inlet	17756.37



JL LIGHT BRACKETS

Wrangler JL owners now have some clever and capable options when it comes to mounting auxiliary off-road lights. Rugged Ridge offers a Cowl Light Bar Bracket Set that mounts to the cowl directly behind the factory hood hinges, securely positioning any 40-inch LED light bar in the perfect spot for illuminating the blackest of trails. For those who prefer the versatility of smaller cube LEDs, our Cowl Cube Mounts mount on either side of the hood, using factory cowl hardware, and provides a staggered mounting platform for a pair of LED cubes. All JL Light Brackets are constructed of sturdy steel and are powder coated with a satin black finish for greater resistance to corrosion.

Cowl Light Bar Bracket	Part N ^o	Cowl Cube Mounts	Part N ^o
Satin Black, Set	11232.71	Satin Black, Inside, Pair	11232.72
		Satin Black, Outside, Pair	11232.73



JL RUBICON CHOP BRACKET

Modifying JL Rubicon flares for off-road is easy and the look is nothing short of heroic with the Rubicon Fender Chop Bracket Kit. By removing the bulky factory fender light assembly, you'll have greater clearance for oversized tires with nothing to get between you and that next obstacle. We've built-in bullet-style side marker and turn signal lights to ensure safe on-road operation too. Brackets come in pairs and feature a satin black powder coat finish.

Wrangler JL	Part N ^o
Satin Black, Pair	11640.92

2-INCH RECEIVER HITCH

Rugged Ridge proudly offers a 2-inch Receiver Hitch Assembly for Wrangler JL models. With a 3,500 lb. towing capacity and a 350 lb. tongue weight, you'll be equipped for getting your gear to wherever the adventure is.

Wrangler JL	Part N ^o
Receiver Hitch Kit	11580.57
Hitch	11580.11
Wiring Harness	17275.04

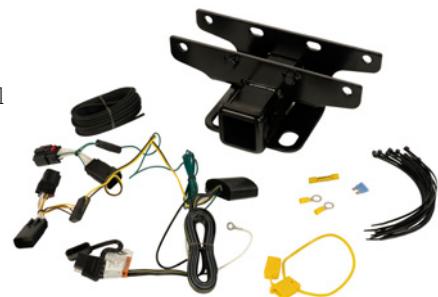



STEEL TUBE FENDER FLARES

Rugged Ridge Tube Fenders were engineered for those die-hard few that love leaving the pavement behind but despise the cringe-worthy sound of tire meeting flare. Outfit your rig to increase your tire clearance, reduce those horrible churning noises and find a whole new unpolished persona. You'll find yourself wheeling with a whole new level of confidence.

07-18 Wrangler JK	Part N ^o
Front	11615.46
Rear	11615.47
Front and Rear	11615.48



ALUMINUM INNER FENDER LINERS

The perfect complement to any off-road fender upgrade is remembering to upgrade those flimsy stock fender liners. Rugged Ridge Aluminum Inner Fenders are a straight-forward and clean way to complete the look of your 07-18 Wrangler JK without breaking the bank. Crafted from lightweight aluminum plate, brake-formed and engineered for a precise fit making it a direct replacement for the front factory liners.

07-18 Wrangler JK	Part N ^o
Front	11615.07





STEEL GRAB HANDLES

Rugged Ridge Steel Grab Handles give lifted Jeep owners a helping hand when climbing in and out of their rigs. Constructed from high-strength tubular steel, each handle is positioned at the forward corner of the door opening-right where it's needed most.

07-18 Wrangler JK	Part Nº
Front and Rear	13505.40
Front	13505.41
Rear	13505.42



ALUMINUM GRAB HANDLES

Tough trail-rated rigs don't just ask for tough accessories... they demand them. Nothing suits that need for strength and stability like a set of Aluminum Grab Handles. These handles feature solid aluminum construction, cross-drilled for a hard-core appeal and then coated with a slick black enamel finish that's as polite & proper as a set of brass knuckles.

07-18 Wrangler JK	Part Nº
Front and Rear	13505.50
Front	13505.51
Rear	13505.52





Full-Width



Rear



Stubby

SPARTACUS™ STAMPED STEEL BUMPERS

The Spartacus™ Stamped Steel Bumpers feature a tough satin black powder-coated finish on a sturdy 11 gauge stamped steel construction allowing for the most advanced styling on the market. It's lighter than most aftermarket steel bumpers. Patent No. D800,036.

Wrangler JL	Part №	07-18 Wrangler JK	Part №
Full-Width Front	11544.21	Full-Width Front	11544.01
Full-Width w/ Winch Plate	11544.23	Full-Width w/Override	11544.09
Stubby Front Bumper	11544.24	Stubby Front Bumper	11544.05
Winch Plate	11543.16	Winch Plate	11543.13
Rear Bumper	11544.25	Rear Bumper	11544.51



SPARTACUS™ HD TIRE CARRIER

The Spartacus™ HD Tire Carrier System provides the ultimate in strength and stability for mounting your oversized wheel and tire. Designed to manage the amplified force and vibrations produced during extreme off-road conditions, the precision die-cast aluminum Hinge Casting provides maximum strength without the excess weight of steel. US Patent No. D758,829



Wrangler JL	Part N°
HD Tire Carrier Kit	11546.55
HD Tire Carrier, Hinge Casting	11546.56
HD Tire Carrier, Wheel Mount	11546.57

07-18 Wrangler JK	Part N°
HD Tire Carrier Kit	11546.50
HD Tire Carrier, Hinge Casting	11546.51
HD Tire Carrier, Wheel Mount	11546.52
Off-Road Jack Mounting Bracket Kit	11586.08



Override (11540.61) sold separately.

RUGGED RIDGE HD BUMPERS

Rugged Ridge HD Series Bumpers are trail-tested, proven designs that pack a serious punch. Whether you prefer the narrow, agile angles of our HD Stubby Front Bumper or the burly look of the Full-Width, you will love the aggressive off-road presence they provide. Engineered to mount most any aftermarket winch for greater versatility and well-equipped to perform in the clutch with built-in jack lifting points at every corner and massive recovery hooks, each one dual-drilled to work with both 3/4 and 7/8-inch shackles (shackles not included). We've even designed an HD Rear Bumper to go out back, for a highly-functional, total bumper package. Add a beautiful satin black powder coat finish and the confidence of our Limited 5 Year Warranty and the choice becomes clear. Rugged Ridge HD Bumpers are the best-built bumpers in their price class...or any class.

Wrangler JL/JK	Part N ^o
Full-Width Front Bumper	11540.31
Stubby Front Bumper	11540.32
Rear Bumper	11540.36



Override (11540.62) sold separately.



JK XHD MODULAR BUMPERS

The XHD Bumper's modular design provides dozens of different looks and styles, you can build the exact bumper of your choice! All components are constructed of heavy-duty textured black powder coated steel. US Patent NO. 7,703,834 & 8,393,656 & 8,764,080

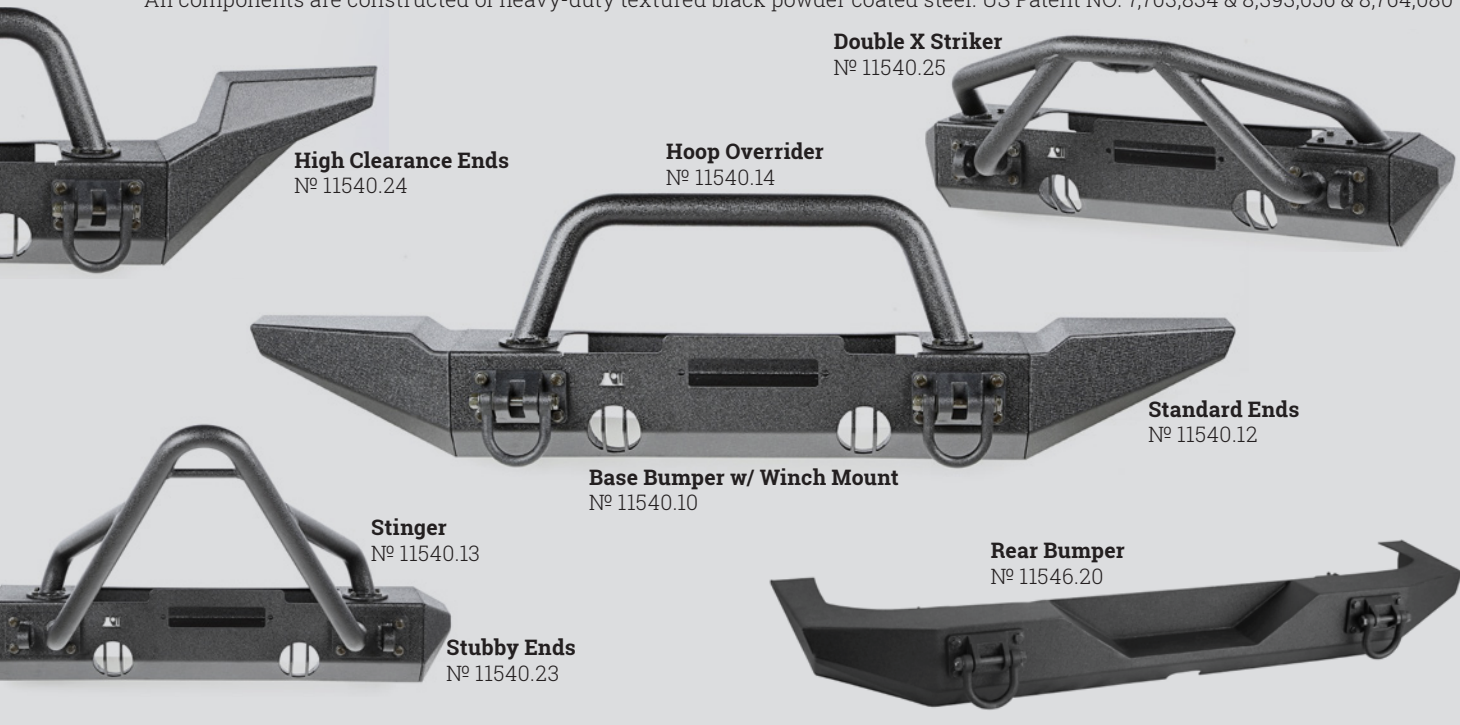

JK ALL TERRAIN MODULAR BUMPERS

Modeled after our XHD Modular Bumper System, but with the more budget-oriented consumer in mind. The All Terrain Modular Bumper System is built from black powder coated steel and has a renewed focus on style and functionality, allowing owners to design and build a bumper to fit their specific needs. Patent No. 7,703,834 & 8,393,656 & 8,764,080





Includes factory back up sensor provisions!

JL SPARTAN™ BUMPERS

The bumper engineered for the Jeep enthusiast that wants the look of a classic off-road style bumper without the extra weight and heavy price tag. The Spartan bumper is built from high-strength plate steel that utilizes fold & weld construction for greater structural integrity, precise fit and a high-quality appearance. It's available with standard or high clearance ends. Patent pending.

Wrangler JL - Satin Black

	Part №
High Clearance Ends, Front	*11548.41
Standard Ends, Front	11548.43
Standard w/ Override	11548.42
Full-Width Rear	11548.51

**JL Wrangler with Rubicon flares will experience a small gap between the bumper and the flare.*



Satin Black finish shown



Textured Black finish shown

JK SPARTAN™ BUMPERS

07-18 Wrangler JK - Satin Black	Part №
High Clearance Ends, Front	11548.71
Standard Ends, Front	11548.73
Standard w/ Override	11548.72
Full-Width Rear	11548.80
Body-Width Rear	11548.81

07-18 Wrangler JK - Textured Black	Part №
High Clearance Ends, Front	11548.01
Standard Ends, Front	11548.03
Standard w/ Override	11548.02
Full-Width Rear	11548.20
Body-Width Rear	11548.21

SPARTAN™ NERF BARS

The ideal solution for JK owners looking for a little help climbing into their lifted Jeep without sacrificing that aggressive look. Spartan Nerf Bars feature a 3-inch OD primary tube that fits in a higher position than conventional tube steps, while patented drop-down step hoops at each door gives you firm footing for easy entry & exit.

Wrangler JL	Part N°	07-18 Wrangler JK	Part N°
4-Door, Satin Black	11596.04	07-11, 2-Door	11596.01
2-Door, Satin Black	11596.03	07-18, 4-Door	11596.02
		12-18, 2-Door	11596.05



RRC ROCKER GUARDS

This true Rock Crawling design puts protection tight up under the side of your Jeep® while adding a special side "hoop" to block those large outcroppings. A special no drill frame mounted design provides secure, bounce-free installation.

Wrangler JL	Part N°	07-18 Wrangler JK	Part N°
4-Door, Satin Black	11504.36	4-Door	11504.22
2-Door, Satin Black	11504.37	2-Door	11504.23

RRC SIDE ARMOR

Keep your Jeeps rocker panels from being beaten to a pulp on the rocks with our RRC Side Armor. Built from heavy duty 2" o.d. steel tubing with a 0.120-inch wall thickness, these guards will take the beating that was meant for your sheet metal and come back for more. Sold as a pair.

07-18 Wrangler JK	Part N°
4-Door, Textured Black	11504.20
2-Door, Textured Black	11504.21



RRC SIDE ARMOR GUARD PLATES

RRC Side Armor Guard Plates are the perfect addition for your RRC Side Armor (11504.20-21) and Rocker Guards (11504.22-23). The Side Armor Guard Plates give a solid platform to assist with vehicle entry that look great and are engineered to last. Sold as a pair.

07-18 Wrangler JK	Part N°
2-Door, Textured Black	11504.24
4-Door, Textured Black	11504.25

XHD ROCK SLIDERS W/ INTEGRATED STEPS

This innovative one-piece design is manufactured from CNC-laser cut 3-mm steel plate and finished with a tough black coating. Each Rock Slider features an integrated four-inch step making climbing in and out of Jeeps easier.

Wrangler JL	Part N°	07-18 Wrangler JK	Part N°
4-Door, Satin Black	11504.32	4-Door, Textured Black	11504.18
2-Door, Satin Black	11504.33	2-Door, Textured Black	11504.17







11232.53 shown

ELITE FAST TRACK WINDSHIELD LIGHT BAR™

The light bar utilizes integrated aluminum channels which allows for unlimited configurations of your lights, trail mirrors, camera and accessory mounts, based on your changing needs. Patent Pending.

07-18 Wrangler JK	Part N°
Elite Fast Track	11232.50
Elite Fast Track 50-Inch Light Bar	11232.52
Elite Fast Track 50-Inch Light Bar Kit	11232.53



N° 11232.52



LED LIGHTING



LED Rock Light Kit
Lights | N° 11232.39
Kit w/ Wiring Harness | N° 11232.40



50-Inch Round LED
144 watt, 17K lumens | N° 15209.06



13.5-Inch Round LED
72 watt, 6072 lumens | N° 15209.11



LED Tail Lights
N° 12403.88



3.5-Inch Round LED
18 watt, 1080 lumens | N° 15209.01



JK 3rd Brake Light LED Ring
N° 11585.04



JL 3rd Brake Light LED Ring
N° 11585.06



TREKKER WINCHES

The Rugged Ridge Trekker Series of electric recovery winches offer today's off-road enthusiast trail-proven reliability and impressive power, with the quality and features that ravage the competition. The brawn behind the Trekker Series lineup is the heavy duty 5.6 / 6.6 series-wound motor that delivers consistent pull strength through a bulletproof 3-stage planetary drive gear. A 212:1 gear ratio means you see quicker line speeds, getting you back to wheeling in record time. And since the real world is where these winches really shine, we equipped them to survive in the worst conditions imaginable. With an IP-68 waterproof rating, they are practically impervious to all the water, dirt and sand that leaves lesser winches in a billow of smoke. Trekker Series Winches are available with a handy wireless remote and 26-meter synthetic line or with a traditional steel cable and a weatherproof wired remote. Best of all, we back every one with an industry-leading five year limited warranty.

Synthetic Rope Winch	Part N°	Cable Winch - Wireless capable with N° 15103.36	Part N°
10,000 lb, Trekker S10, Wireless	15100.08	10,000 lb, Trekker C10	15100.07
12,500 lb, Trekker S12.5, Wireless	15100.25	12,500 lb, Trekker C12.5	15100.24



TRACTION RECOVERY KIT

We've made it possible to take traction with you, no matter where you go. Our Traction Recovery Kit features heavy-duty reinforced nylon traction boards, delivering essential grip on the slickest of surfaces. Sand, snow and mud are simply no match for the board's design, as the built-in cleats deliver a giant dose of traction when and where it's needed. The board is engineered to withstand pressures up to 20,000 lbs. and paired with a handy tri-fold shovel for ease of placement.

Universal	Part N°
Traction Boards and Shovel	15104.46

RECOVERY GEAR KIT

The Recovery Gear Kit includes everything you need to help your buddy next time he gets stuck in the mud. The durable carrying case is filled with our most popular recovery products to make sure you can get out of those trouble spots quickly and safely.

Universal	Part N°
20,000 lb Kit	15104.25
30,000 lb Kit	15104.29





ROPE SHACKLE

Constructed of an ultra-strong HMPE rope material, these shackles are considerably stronger than steel. With a 30,000 lb. breaking strength, they repel water, resist abrasions and have very low elasticity making them the obvious choice for off-road recovery.



Universal	Part Nº
7/16 inch, 8250 lb, Gray, Each	11235.50
5/16 inch, 4,650 lb, Gray, Each	11235.51
7/16 inch, 8250 lb, Gray, Pair	11235.52
5/16 inch, 4,650 lb, Gray, Pair	11235.53



3/4" | Nº 11235.30
7/8" | Nº 11235.40

3/4" | Nº 11235.31
7/8" | Nº 11235.41

3/4" | Nº 11235.32
7/8" | Nº 11235.42

3/4" | Nº 11235.33
7/8" | Nº 11235.43

3/4" | Nº 11235.34

D-RING ISOLATOR

Put an end to the loud clanging and banging of your d-ring shackles! Rugged Ridge D-Ring Isolators are designed to isolate all portions of recovery shackles from contacting your bumper, virtually eliminating the obnoxious noise from your off-road rig.

RECOMMENDED TOWING ACCESSORIES

WARNING



Trailer Hitch Extension
Nº 11580.50



Aluminum 2-Inch Draw Bar
Nº 11237.05



JK Trailer Hitch Kit
Nº 11580.60

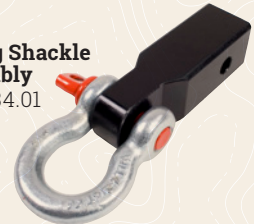

D-Ring Shackle Assembly
Nº 11234.01



Cargo Rack w/ Hitch
Nº 11580.20



Soft Shackle Hitch Eyelet Kit
Nº 11235.57



2-Inch Draw Bar
Nº 11237.02



Tow Hook
Nº 11237.01



JL Trailer Hitch Kit
Nº 11580.11



Hitch Ball
2x3/4-Inch | Nº 11305.01
1-7/8x3/4-Inch | Nº 11305.02

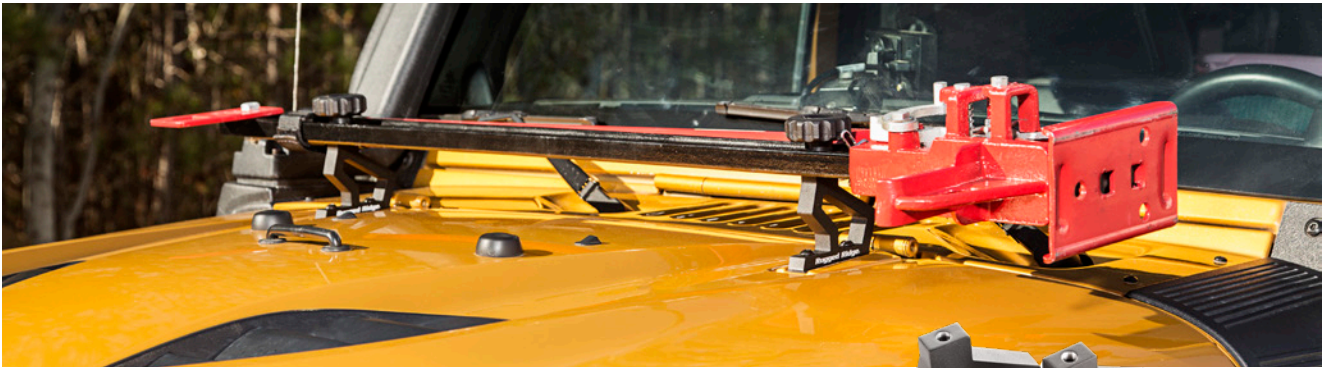

HOOD MOUNT OFF-ROAD JACK HOLDER

We developed these jack mounts to be lightweight but sturdy by building them from high-strength 6061 T6 aluminum and treated to a durable textured black powder-coat to keep them looking great for years of trail duty.

07-18 Wrangler JK

Part Nº

Non-locking

11586.04



RECOMMENDED OFF ROAD JACK ACCESSORIES



Off Road Jack Mount Spacer Kit
Nº 11586.03



Jack Roll Bar Mounting Bracket
Nº 11586.02



Off Road Jack Handle Strap
Nº 13305.60

JK Off Road Jack Mount
Nº 11586.01



SPARE TIRE TOOL RACK SYSTEM

The Spare Tire Tool Rack System is an excellent way to equip your rig with the tools to survive any off-road excursion. Each tool rack is built from high-strength power coated steel plate and, with a three-groove rack, will house a variety of tools and implements including axes, shovels, picks, saws, etc.

Universal

Part Nº

Tool Rack System

13551.63



JL ECLIPSE™ SUN SHADES

Open air and top down feeling you want, while providing added protection from harsh sunlight.

Wrangler JL	Part №
4-Door Full, Black	13579.71
4-Door, Front, Black	13579.72
4-Door Hardtop, Front, Black	13579.73
2-Door Front, Black	13579.74
2-Door Full, Black	13579.75



JK ECLIPSE™ SUN SHADES

07-18 Wrangler JK	Part №
4-Door Full, Black	13579.05
2-Door Full, Black	13579.06
2 & 4-Door, Front, Black	13579.04
2 & 4-Door Hardtop, Front, Black	13579.10
4-Door Full, Red	13579.25
2-Door Full, Red	13579.26
2 & 4-Door, Front, Red	13579.24
2 & 4-Door Hardtop, Front, Red	13579.40
2 & 4-Door, Front, Flag	13579.14
2 & 4-Door Hardtop, Front, Flag	13579.20
2 & 4-Door, Front, Total Eclipse	13579.15

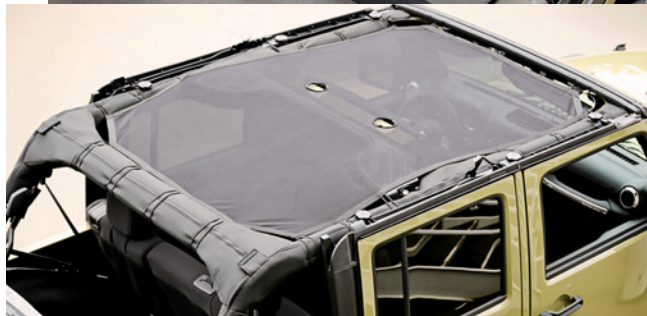



MONTANA™ BOWLESS TOP

Precise engineering allows for a secure and formed fit over the factory sports bar. Supplied “whisper bars” dramatically reduce wind and road noise commonly associated with other frameless soft top designs. These Bowless Soft Tops also feature useful zippered mesh corner pockets for extra storage.

07-18 Wrangler JK	Part N°
4-Door	13790.38
2-Door	13790.39



MONTANA™ SOFT TOPS

A direct OE replacement to match factory fabric, each color is specially formulated to match the original factory equipment colored top.

Diamond Black	Part N°
4-Door, 10-18 Wrangler	13772.35
2-Door, 10-18 Wrangler	13767.35
4-Door, 07-09 Wrangler	13771.35
2-Door, 07-09 Wrangler	13766.35

CARGO NET SYSTEM

The Cargo Net System protects and contains your cargo to keep you on the go with ease and keep your gear in place. With easy installation, high quality nylon webbing, nickel hardware, and no hassle removal, you can ensure the security of your gear while off-roading. Our net system is reinforced around the edges for a strong, durable, and clean look.

07-18 Wrangler JK	Part N°
4-Door, Full	13552.71
2-Door, Full	13552.70



JK ECLIPSE™ CARGO BARRIER

The Eclipse™ Cargo Barrier is designed to allow open-top enjoyment while providing protection from harsh sunlight and wind for your rear seat passengers. Constructed of reinforced mesh with integrated bungee straps, this 3-piece barrier installs easily to your sport bar and tub rails in minutes for the utmost in convenience.

07-18 Wrangler JK	Part N°
4-Door	13579.42
2-Door	13579.41

WINDSHIELD HEADERS



HEADERS ⚠ WARNING

These upgraded Windshield Headers install quickly and easily!

07-18 Wrangler JK	Part N°
Aluminum, 2 & 4-Door	13308.05
Stamped Steel, 2 & 4-Door	13308.06



SOFT TOP & EXO-TOP™ HEADER KIT

Kit includes a tailgate bar, right side tailgate bar retainer, left side tailgate bar retainer, and a header.

Wrangler JK	Part N°
4-Door, 10-17 Wrangler w/ cable-style top	13516.10



FREEDOM PANEL STORAGE BAG

This black vinyl storage bag offers a quick and affordable solution to protecting your hard top Freedom Panels, allowing you to enjoy the great outdoors.

Wrangler JL/JK	Part N°
Black	12107.06



JK SOFT TOP STORAGE BOOT

Want your soft top protected while you cruise around with the top down? Our Soft Top Storage Boot is the solution.

07-18 Wrangler JK	Part N°
4-Door	12104.51
2-Door	12104.50



DOOR STORAGE BAG

Prolong the life of your hard doors with this handy storage option from Rugged Ridge®.

Wrangler JL/JK	Part N°
Front, Pair	12108.10
Rear, Pair	12108.20



WINDOW STORAGE ROLL BAG

Protect your soft top windows from scratching and other damage with a Window Storage Roll Bag from Rugged Ridge®.

07-18 Wrangler JK	Part N°
07-18 Wrangler	12107.05



EXO-TOP™

The Exo-Top™ takes convenience, function, and style to new levels by allowing Jeep® owners the ability of conveniently lowering, raising or removing the Jeep's soft top without having to unload gear from the roof-rack. Integrated into the 300-lb capacity roof rack is an advanced, externally suspended, soft-top design that fastens using a series of Velcro straps along the perimeter bars of the roof rack. The Exo-Top™ features a direct bolt-on design with no drilling required for installation. US Patent No. 9,376,002;D748,038



07-18 Wrangler JK

Part №

4-Door	13516.02
2-Door	13516.01

07-08 models with a plastic header are recommended to upgrade to № 13516.10 header for best results.



SHERPA ROOF RACK SYSTEM

The Sherpa Roof Rack System is an easy bolt-on solution for the Wrangler JK. The unique tilt feature allows you to access your soft or hard top with ease. The rack has a 300-lb static weight rating and the forward mounting bar acts as an integrated light bar.

07-18 Wrangler JK

Part №

4-Door	11703.02
2-Door	11703.01
Sherpa Roof Rack Cross Bar Adapter	11703.10
Sherpa Roof Rack Cross Bar	11703.11
4-Door Kit*	11703.22
2-Door Kit*	11703.21

* Includes rack, crossbar adapters and two 56.5-inch round cross bars.





ECLIPSE TUBE DOOR COVERS

Rugged Ridge Eclipse Tube Door Covers give JK owners the ability to enjoy the open air element of their Rugged Ridge tube doors while providing a higher level of containment for the passenger area and its contents.

Wrangler JL	Part N°	07-18 Wrangler JK	Part N°
Front and Rear Set	13579.55	Front and Rear Set	13579.52
Front	13579.53	Front	13579.50
Rear	13579.54	Rear	13579.51



RECOMMENDED TUBE ACCESSORIES



- ① **Tube Door Arm Rest**
N° 13579.60
- ② **JK Quick Release Mirrors**
Round | N° 11025.11
Rectangular | N° 11025.13
Stubby, Round | N° 11025.19
Stubby, Rectangular | N° 11025.20
- ③ **Wall Mount Door Holder**
N° 12107.10
- ④ **OMIX Factory Style Mirrors**
Pair | N° 11002.21
- ⑤ **JL Quick Release Mirrors**
Round | N° 11025.23
Rectangular | N° 11025.24
Round Pair | N° 11025.25
Rectangular Pair | N° 11025.26



JL TUBE DOORS

A stylish design that is meant to be seen, not heard. These Rugged Ridge tube doors are free from the dreaded rattling common with other tube doors. Larger diameter tubing, an innovative door latch, and adjustable hinges provide the best looking, best fitting tube door on the market. Patent pending.

Wrangler JL	Part N°
Front, Pair	11509.13
Rear, Pair	11509.14
Front w/ Mirrors	11509.15



JK TUBE DOORS

Rugged Ridge Tube Doors are constructed from durable 1.5-inch mandrel bent steel tube that is E-coated, primed and powder coated for a long lasting finish. They interchange easily with the factory doors.

07-18 Wrangler JK	Part N°
Front, Pair	11509.10
Rear, Pair	11509.11



RUGGED RIDGE WHEELS

Rugged Ridge wheels are designed to exactly center the wheel over the hub. Providing the best fit possible and the proper clearance for brake rotors, steering components, and suspension. Better fit means no wheel vibration! Rugged Ridge wheels are certified to meet/exceed SAE J2530 standards for wheel strength and durability. Backspacing is 5.17 inch with a +10mm offset, load rating is 2200 lbs and bore diameter is 71.5mm.



JESSE SPADE WHEELS

17x9 Wheels	Part N°
Satin Black	15303.90
Gun Metal	15303.92
Center Cap for Jesse Spade Wheel	15303.94



XHD WHEELS

US Patent No. D761,183, 9, 242, 506.

17x8.5 Wheels	Part N°	17x9 Wheels	Part N°	18x9 Wheels	Part N°	20x9 Wheels	Part N°
Satin Black	15301.60	Satin Black	15301.01	Satin Black	15305.01	Satin Black	15306.01
Gun Metal	15301.61	Chrome	15301.20	Gun Metal	15305.30	Gun Metal	15306.02
Rim Protector, Black	15250.02	Gun Metal	15301.30	Silver	15305.40	Silver	15306.03
		Silver	15301.40	Rim Protector, Black	15250.03	Rim Protector, Black	15250.04
		Rim Protector, Black	15250.02				



DRAKON WHEELS

US Patent No. D701,156.

17x9 Wheels	Part N°	18x9 Wheels	Part N°	20x9 Wheels	Part N°
Satin Black	15302.01	Satin Black	15302.02	Satin Black	15304.01
Gun Metal	15302.30	Gun Metal	15302.31	Gun Metal	15304.30



TRAIL RUNNER WHEELS

17x9 Wheels	Part N°
Gun Metal, with Center Cap	15500.77
Gloss Black, with Center Cap	15500.78



STEEL D-WINDOW WHEELS

17x9 Wheels	Part N°
Black	15500.70
Chrome Center Cap	15201.54

RECOMMENDED WHEEL ACCESSORIES

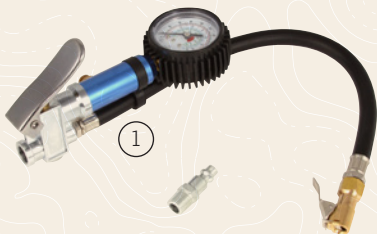

① **Tire Inflator/Deflator**
N° 15104.55



② **Lug Nut & Wheel Locks**
Lug Nut, 1/2in x 20, Black, Acorn Hex | N° 16715.07
Lock Set (5), 1/2in x 20, Chrome | N° 16715.20
Lock Set (5), 1/2in x 20, Black | N° 16715.21
Tire Carrier Lock, Chrome | N° 16715.22
Lug Nuts (20), 1/2in x 20, Black | N° 16715.23
Lug Nuts (20), 1/2in x 20, Red | N° 16715.24

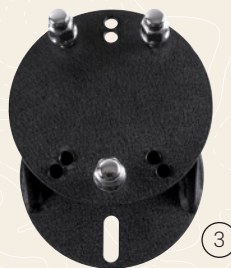

③ **Heavy Duty Tire Spacer**
N° 11585.02



④ **Wheel Spacers & Adapters**
1.5-in Spacer | N° 15201.05
1.75-in Spacer | N° 15201.17
1.375-in Adapter | N° 15201.07
1.25-in Adapter | N° 15201.15



XHD ARMOR FENDERS

Sturdy all-steel construction with welded seams and a heavy textured black powder coat makes these fenders capable of absorbing abuse while delivering head-turning good looks. Patent Pending.

07-18 Wrangler JK	Part N ^o
Front Fenders	11615.01
Rear Fenders, 4-Door	11615.02
Rear Fenders, 2-Door	11615.03



HURRICANE FLAT FENDER FLARES

Constructed of durable injection molded thermoplastic material, the flares rest high on the vehicle providing 2-inches of extra vertical clearance with an additional 1-inch of extra width for oversized wheels while on trails. Patent No. D712, 324

07-18 Wrangler JK	Part N ^o
Textured Black	11640.10
Smooth Black Kit	11640.25
Textured Black, EU Model*	11640.09
Smooth Black, EU Model Kit*	11640.26

* Comes with E-Marked side markers





TUBE FENDERS

Rugged Ridge Tube Fenders were engineered for those die-hard few that love leaving the pavement behind but despise the cringe-worthy sound of tire meeting flare. Available with a rugged matte black finish.

Wrangler JL	Part N°	07-18 Wrangler JK	Part N°
Front, Pair	11615.71	Front, Pair	11615.46
Rear, Pair	11615.72	Rear, Pair	11615.47
Front and Rear Kit	11615.73	Front and Rear Kit	11615.48



11615.46

ALL TERRAIN FLAT FENDER FLARES

These exciting flares are out-of-the-box ready to turn your street Jeep® into an off road machine. Replace your original flares with these and run larger tires without interference from the flare.

07-18 Wrangler JK	Part N°
Flares	11620.10
Flares & Liner Kit	11620.11



RECOMMENDED ACCESSORIES



REPLACEMENT
 ① Flare Wheel Liner Kit
 N° 11620.50



UPGRADE
 ② JL Aluminum Inner Fender
 Front | N° 11615.61, Rear N° 11615.62
 JK Aluminum Inner Fender
 Front | N° 11615.07



ALUMINUM HOOD CATCHES

The Rugged Ridge Aluminum Hood Catches are built as a stronger direct replacement for the OE catches. These hood catch kits are adjustable, durable and aesthetically pleasing. The adjustable tension rod guarantees a precise fit. US Patent No. D692,290.



Wrangler JL	Part N°	07-18 Wrangler JK	Part N°
Black, Pair	11210.21	Black, Pair	11210.11
Textured Black, Pair	11210.27	Textured Black, Pair	11210.17
Silver, Pair	11116.21	Silver, Pair	11116.07



NIGHTHAWK LIGHT BROW

The NightHawk Light Brow changes your factory Jeep JK grille, simply and dramatically, from clean to down-right mean. Built from durable high-density ABS and comes in your choice of a bare finish or painted to match factory colors. Installation is a breeze, taking less than 5 minutes with no drilling required.

07-18 Wrangler JK	Part N°	07-18 Wrangler JK	Part N°
Black, Paintable	12034.41	Cherry	12034.41PRP
Granite Crystal	12034.41PAU	Bright Silver	12034.41PS2
Hydro Blue	12034.41PBJ	Billet Silver	12034.41PSC
Anvil	12034.41PDS	Dune	12034.41PTT
Tank	12034.41PGK	Bright White	12034.41PW7
Copper Brown	12034.41PLB	Black	12034.41PX8
Flame Red	12034.41PR4	Amped	12034.41PYC
Firecracker Red	12034.41PRC		



PERFORMANCE VENTED HOOD

Rugged Ridge's Performance Vented Hood was engineered to provide 50% more ventilating surface area over similar designs to help heat escape from the engine compartment to maximize engine efficiency. Made from high quality stamped steel, the hood uses a factory style inner core assuring it fits like the OE hood. US Patent No. D718,682

07-18 Wrangler JK	Part N°
Hood	17759.01
Hood Insert	17759.09
Hood and Insert Kit	17759.02





ROCKER PANEL BODY ARMOR

Rugged Ridge's new Rocker Panel Body Armor offers the perfect solution in rugged off-road protection. These rocker panels are constructed of impact resistant polycarbonate. This easy no drill solution attaches to your vehicle with super strong automotive grade acrylic adhesive tape and bolts. Available for both 2 and 4 door Wranglers.



Wrangler JL	Part N°	07-18 Wrangler JK	Part N°
4-Door	11651.61	4-Door	11651.12
2-Door	11651.62	2-Door	11651.11

WINDOW VISORS & BUG DEFLECTORS

Constructed of durable scratch resistant acrylic, these wind and bug deflectors easily install with special automotive grade tape and screw attachments. The window visors are aerodynamically designed to reduce wind noise while channeling airflow to keep your vehicles interior free of rain, smoke, stale air and window fogging. Keep bugs and road debris off of your hood and windshield with our Bug Deflector.



Window Visors	Part N°	Bug Deflectors	Part N°
4-Door, Matte Black, JL	11349.17	Matte Black, 07-18 JK	11348.02
2-Door, Matte Black, JL	11349.16	Smoked, 07-18 JK	11350.02
4-Door, Matte Black, 07-18 JK	11349.12		
2-Door, Matte Black, 07-18 JK	11349.11		
4-Door, Smoked, 07-18 JK	11351.12		
2-Door, Smoked, 07-18 JK	11351.11		



ALL TERRAIN ENTRY GUARDS

Designed to prevent the accelerated wear and tear common to door sill areas. The All Terrain Entry Guards prevent unsightly scuffs and scratches, preserving your Jeep's door threshold area. Installs in minutes with adhesive foam tape. US Patent No. D627,285

Wrangler JL	Part N°	07-18 Wrangler JK	Part N°
4-Door	11216.32	4-Door	11216.21
2-Door	11216.31	2-Door	11216.20



AVAILABLE SUMMER 2019

JL SNORKEL

Drawing from our experience with the JK snorkel, we engineered the Rugged Ridge XHD Snorkel System for Wrangler JL to be the best option on the market. We started with an aesthetic design inspired by the JL's fender vents, so that it looks more like a natural part of the vehicle. The low-mount intake is the focal part of the system, and likely the component that will get the most use. Also available is our high-mount ram intake. It mounts in minutes and pulls in fresh air from the top of the windshield, high above the water line, for confident fording of rivers and streams. We've even designed an optional pre-filter element for use in the dustiest of desert conditions. A convenient manual drain valve at the lowest part of the system allows any negligible water migration to be drained from the system quickly and easily.

Wrangler JL	Part N°
Low/High Mount Snorkel System	17756.31
Low Mount	17756.35
High Mount Extension	17756.36
Ram Inlet	17756.37

JK XHD MODULAR SNORKEL

The XHD Modular Snorkel System is the most versatile snorkel system on the market. Designed to protect your vehicle from accidental water ingestion, the snorkel gives the user the ability to adapt it to changing conditions. The main snorkel body features a built-in manual drain valve to release any moisture that might enter it. The entire system installs with only minor modification to the JK fender and, unlike other snorkel systems, does not require any cutting to the exterior sheet metal. Patent D687,071 / D687,072

07-18 Wrangler JK, 3.6L & 3.8L	Part N°
Modular XHD Snorkel Low Mount Kit	17756.06
Modular XHD Snorkel Low Mount	17756.08
Modular XHD Snorkel Kit*	17756.21
Modular XHD Snorkel High Mount w/ Ram Intake	17756.07
Modular XHD Snorkel w/ Pre-filter	17756.22
Modular XHD Snorkel Pre-filter	17756.09

*Includes Low Mount & Ram High Mount

07-18 Wrangler JK, Diesel	Part N°
Low/High Mount, Diesel	17756.23
Low Mount Kit, Diesel	17756.04
Pre-Filter Kit, Diesel	17756.24





STAINLESS STEEL AXLE-BACK EXHAUST SYSTEM

Open up your Wrangler's exhaust with this dual exhaust system. The 2 1/4-inch mandrel bent pipes give hot exhaust gases a smooth exit without the restrictions found in crush-bent pipes. The additional exhaust flow will increase the horsepower and torque of your 3.8L or 3.6L engine. This is a bolt-on system that installs after the catalytic converter to keep your emissions legal.



07-18 Wrangler JK	Part Nº
Polished	17606.75
Black	17606.77



JK HEAVY DUTY OFF-ROAD MUFFLER

Designed to deliver a more aggressive tone than the stock muffler, the off-road muffler produces a deep tone throughout the RPM range. It sits as high as possible for better ground clearance. The exhaust routing is designed to be protected by the Jeep's frame to reduce trail damage.

07-18 Wrangler JK	Part Nº
Off-Road Muffler	17606.70

RECOMMENDED ACCESSORIES



① **Exhaust Spacer Kit**
Nº 17606.76



② **Cold Air Intake System***
12-18 Wrangler 3.6L | Nº 17750.07
07-11 Wrangler 3.8L | Nº 17750.06
** Not legal for sale or use in California or other states adopting CARB standards.*



③ **Throttle Body Spacer***
12-19 Wrangler 3.6L | Nº 17755.03
07-11 Wrangler 3.8L | Nº 17755.02



④ **Stainless Headers***
Nº 17650.53



TRAIL ACCESS

Program

Act now before it is too late! Rugged Ridge's Trail Access Program is designed to support the 4WD community by protecting trail access. Grants are now available for 2019. This easy grant application is available to US 501 (c) non-profit organization and Canadian non-profit organizations. Grant available up to U\$5,000 and must be used for public full-size 4WD vehicle trails.

Grants now available for US & Canadian trails.



CREATE. MAINTAIN. PROTECT.

For more information visit RuggedRidge.com/trailaccess



YOUR JEEP.[®]
YOUR ADVENTURE.[™]



**RUGGED
RIDGE** | ELITE

The Rugged Ridge ELITE Series accessories are designed with the most discerning Jeep® enthusiast in mind. Innovative patented designs, high-quality materials and exclusive premium finishes combine for a distinctive style and appearance like no other.

① **Elite Headlight Guard**
Wrangler JL | Nº 11230.21

② **Elite Tail Light Guard**
Wrangler JL | Nº 11226.12

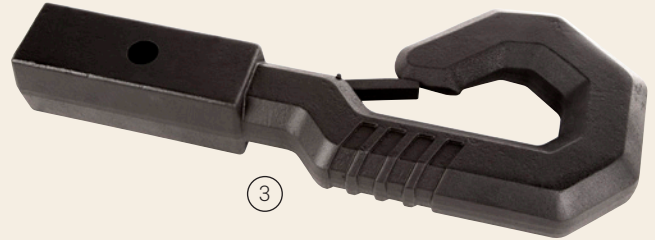

① **Elite Hard Top Quick Removal Kit**
2-Door JL | Nº 13510.15

② **Elite Fire Extinguisher Holder**
Nº 11238.40

③ **Elite Giga Hook**
Black | Nº 11237.20
Red | Nº 11237.21
Pink | Nº 11237.22
Yellow | Nº 11237.23
Green | Nº 11237.24

④ **Elite Antenna Base**
Base | Nº 17212.13
Kit w/ Antenna | Nº 17212.41



① **Elite Headlight Guard**
N° 11230.12

② **Elite Tail Light Guard**
Brushed | N° 11226.04
Black | N° 11226.05

③ **Elite Hard Top Quick
Removal Kit**
2-Door JL | N° 13510.15
2-Door JK | N° 13510.08
4-Door JK | N° 13510.09

④ **Elite Antenna Base**
Base | N° 17212.13
Kit w/ Antenna | N° 17212.41

⑤ **Elite Fire Extinguisher
Holder**
N° 11238.40



③ **Elite Fast Track Light Bar**
Standard | Nº 11232.50
50-Inch Bar | Nº 11232.52

② **Elite Pivotal Headlight Euro Guard**
Pair | Nº 11230.13

③ **Elite Door Handle Insert**
Black, 2-Dr | Nº 13311.48
Black, 4-Dr | Nº 13311.49
Brushed, 2-Dr | Nº 13311.50
Brushed, 4-Dr | Nº 13311.51
Blk Inlay, 2-Dr | Nº 13311.52
Blk Inlay, 4-Dr | Nº 13311.53

④ **Elite Fuel Door**
Brushed Alum. | Nº 11425.10
Black | Nº 11425.12

⑤ **Elite Fuel Caps**
Black | Nº 11229.10
Brushed Alum. | Nº 11229.11





PHONE CENTER CONSOLE COVER

Turn your standard JK center console lid into a stylish and comfortable arm rest, one that conveniently docks your smartphone. The Center Console Arm Rest protects the factory console lid from wear & tear, enhancing the interior style of your 2011-2018 Wrangler JK with a high-tech touch. The Center Console Arm Rest Phone Holder features a recess large enough to hold most larger cellphones and a built-in channel for discretely routing phone charging cables out of sight. Installs quickly and easily using the included two-sided automotive grade adhesive for a secure fitment.

Wrangler JK	Part Nº
11-18 Wrangler JK, Black	13107.62



ALL-TERRAIN CONSOLE COVER

Wrangler JK	Part Nº
11-18 Wrangler JK, Tan	13107.43
11-18 Wrangler JK, Black	13107.42
07-10 Wrangler JK, Tan	13107.41
07-10 Wrangler JK, Black	13107.40



NEOPRENE CONSOLE COVER

Wrangler JK	Part Nº
11-18 Wrangler JK, Tan	13108.01



DASH MULTI-MOUNT SYSTEM™

Easily the most versatile dashboard accessory mounting system available today. Featuring a universal ball mount for driver info gadgets and a tripod stud for both point and shoot or POV cameras; this mounting system allows the driver to use either one individually or both at the same time!. Patent No. 9,132,779, D627,285

Wrangler JL	Part N°
Multi-Mount, Phone Kit	13551.23
Charging Phone Kit	13551.35



N° 13551.28 Qi-compatible Charging Phone holder



11-18 Wrangler JK	Part N°
Multi-Mount, Phone Kit	13551.16
Charging Phone Kit	13551.34



07-10 Wrangler JK	Part N°
Multi-Mount, Phone Kit	13551.17
Charging Phone Kit	13551.33





ALL TERRAIN FLOOR LINERS

Precision engineering, using state of the art technology, ensures an exact fit to the shape and contour of your vehicle's floor. The deeply molded chevron-shape tread pattern channels dirt, mud and snow away from the driver to keep shoes and pant legs clean. The liners are high pressure injection molded from OE-quality thermoplastic that looks and feels like rubber and provides a nonslip surface. US Patents D627,285 & 8,163,369

Rolled reinforced edges provide added strength

Chevron tread channels liquid & dirt away from shoes & clothing

High perimeter walls provide maximum protection & retention

Self-sealing floor hook attachments keep moisture out



Our floor liners utilize nibbed bottoms and floor hooks to keep them safely in place.





Applications	Black	Tan	Gray
Front Liner, Pair, Wrangler JL	12920.36	-	-
Rear Liner, 1-Piece, Wrangler JL 4-Door	12950.48	-	-
Cargo Liner, Wrangler JL 4-Door	12975.49	-	-
Rear Liner, Pair, Wrangler JL 2-Door	12950.49	-	-
Front & Rear Kit, Wrangler JL 2-Door	12987.43	-	-
Front & Rear Kit, Wrangler JL 4-Door	12987.05	-	-
4 piece Kit, Wrangler JL 4-door ~	12988.05	-	-
Front Liner, Pair, 07-18 Wrangler JK	12920.03	13920.03	14920.03
Front Liner, Pair, 07-18 Wrangler JK, RHD	12920.02	13920.02	14920.02
Rear Liner, 1-Piece, 07-18 Wrangler JK 4-Door	12950.01	13950.01	14950.01
Rear Liner, Pair, 07-18 Wrangler JK 2-Door	12950.02	13950.02	14950.02
Cargo Liner, 11-18 Wrangler JK 2 & 4-Door	12975.03	13975.03	14975.03
Cargo Liner, 07-10 Wrangler JK 2 & 4-Door	12975.01	13975.01	14975.01
Front & Rear Kit, 07-18 Wrangler JK 4-Door*	12987.01	13987.01	14987.01
Front & Rear Kit, 07-18 Wrangler JK 2-Door*	12987.02	13987.02	14987.02
4 piece Kit, 11-18 Wrangler JK 4-door*~	12988.04	13988.04	14988.04
5 piece Kit, 11-18 Wrangler JK 2-door**^	12988.03	13988.03	14988.03
4 piece Kit, 07-10 Wrangler JK 4-door*~	12988.01	13988.01	14988.01
5 piece Kit, 07-10 Wrangler JK 2-door**^	12988.02	13988.02	14988.02

* Also fits RHD models

~ Kit includes front, one-piece rear and cargo liner

^ Kit includes front, two-piece rear and cargo liner





C3 REAR CARGO COVER

The Configurable Cargo Cover (C3) offers complete protection for the rear cargo area of your Jeep. By protecting the carpet and plastic trim from damage, scratches, pet claws, dirt, and other debris. Featuring water resistant material, the split fold feature allows for 40-60 rear seat lowering. Patent No. D807,275

Wrangler JL/JK	Part №
Wrangler JL (4-Door)	13260.13
Wrangler JL (2-Door)	13260.14
15-18 Wrangler JK (4-Door)	13260.01
15-18 Wrangler JK (2-Door)	13260.03
07-18 Wrangler JK (4-Door) w/out Subwoofer	13260.01
07-14 Wrangler JK (4-Door) w/ Subwoofer	13260.02
07-18 Wrangler JK (2-Door) w/out Subwoofer	13260.03
07-14 Wrangler JK (2-Door) w/ Subwoofer	13260.04





C3 TAILGATE COVER

The C3 Tailgate Cover protects the interior from scratches and scuffs while adding valuable storage space for items that tend to tumble around in the back.

07-18 Wrangler JK	Part Nº
Black	13260.09



C2 CANINE CURTAIN

The Cargo Curtain provides full top to bottom separation between the seats and the cargo area.

Wrangler JL	Part Nº	07-18 Wrangler JK	Part Nº
Rear Seat	13260.06	Front Seat	13260.05
		Rear Seat	13260.06



LED INTERIOR LIGHTING SYSTEM

The Rugged Ridge LED Interior Lighting System contains everything you need to bring your interior to life with dazzling light. Multi-color acrylic LED tubes illuminate both front and rear passenger foot-well areas, as well as the rear cargo area, for total vehicle coverage. A built-in microphone with sensitivity adjustment lets the music control the light show for the ultimate visual experience.

Wrangler JL/JK	Part N°
LED Interior Light System	11250.09

SWITCH PODS



Lower Switch Pod
11-18 Wrangler
N° 17235.54



Lower Switch Pod
07-10 Wrangler
N° 17235.55



A-Pillar Switch Pod
11-18 JK, LH | N° 17235.58
11-18 JK, RH | N° 17235.59



A-Pillar Switch Pod
07-10 JK, LH | N° 17235.56
07-10 JK, RH | N° 17235.57

LASER ETCHED ROCKER SWITCHES

Want to add a cool custom look to your rig's interior? These laser-etched rocker switches are designed to control all of your electrical lights and accessories with a sharp-looking laser-etched logo that identifies the light's function. Switches are rated for 20 amps with amber LED illumination when the switch is in the ON position.

Rocker Switches	Part N°
Zombie Lights	17235.06
Rock Lights	17235.07
Sasquatch Light	17235.08
Off Road Lights	17235.09
LED Light Bar	17235.10
Set of 5	17235.12





CB RADIO MOUNT

The CB Radio Mount conveniently mounts over the rearview mirror for an easy reach. Made from durable black powder coated steel, now your CB is attached high and within reach without having to take your eyes off the road or trail.

07-18 Wrangler JK

Part N°

CB Radio Mount

11503.95

CB Radio & Antenna Mount Kit

11503.96





ALLOY USA ALUMINUM DIFFERENTIAL COVERS

ALLOY USA Aluminum Differential Covers are constructed from A356-T6 cast aluminum for strong impact resistance. Each cover features a precision machined sealing surface, allowing gaskets or RTV sealant to be used for a leak-free seal. These covers also come complete with a magnetic drain plug and a specially designed dipstick bolt to help avoid under or overfilling their differentials. Patent No. D798,906



11212

07-18 Wrangler JK

Part Nº

Dana 30	11210
Dana 35	11211
Dana 44	11212



61602



61404

ALLOY USA LIFT KITS



When it comes to outfitting your Wrangler for adventure, you can count on ALLOY USA for the most complete lift kits on the market today. With the added protection of our 5-Year Limited Warranty, ALLOY USA Lift Kits are clearly your best choice!

Wrangler JL

Part Nº

2.5" Lift Kit, Fox Shocks, 4-Door	61602
2.5" Lift Kit, 4-Door	61501
4" Lift Kit, Fox Shocks, 4-Door	61702
4" Lift Kit, 4-Door	61701

07-18 Wrangler JK

Part Nº

2.5" Lift Kit, 4-Door	61401
2.5" Lift Kit, 2-Door	61402
4" Lift Kit, 2-Door	61403
4" Lift Kit, 4-Door	61404



RING & PINIONS

JL Front Dana 44™	Part N ^o
4.88 Ratio	D44488RJLX
5.13 Ratio	D44513RJLX

JL Rear Dana 44™	Part N ^o
4.88 Ratio	D44488JLX
5.13 Ratio	D44513JLX

JK Front Dana 30™	Part N ^o
3.73 Ratio	D30373RJK
4.10 Ratio	D30410RJK
4.56 Ratio	D30456RJK
4.88 Ratio	D30488RJK
5.13 Ratio	D30513RJK

JK Front Dana 44™	Part N ^o
4.10 Ratio	D44410RJK
4.56 Ratio	D44456RJK
4.88 Ratio	D44488RJK
5.13 Ratio	D44513RJK
5.38 Ratio	D44538RJK

JK Rear Dana 44™	Part N ^o
4.10 Ratio	D44410JK
4.56 Ratio	D44456JK
4.88 Ratio	D44488JK
5.13 Ratio	D44513JK
5.38 Ratio	D44538JK



RING & PINION MASTER/OVERHAUL KITS

JK Front or Rear Kits	Part N ^o
Dana 30™, Front	352050
Dana 44™, Front	352051
Rubicon, Dana 44™, Rear	352052
Dana 44™, Rear	352053
Micro Kit Dana 30™, Front	152050
Mini Install Kit, Dana 44™	252051

JK Front & Rear Kits	Part N ^o
Dana 30™/44™, 4.10 Ratio	360002
Dana 30™/44™, 4.88 Ratio	360003
Dana 30™/44™, 5.13 Ratio	360004
Dana 44™/44™, 4.10 Ratio	360005
Dana 44™/44™, 4.88 Ratio	360006
Dana 44™/44™, 5.13 Ratio	360007
Dana 44™/44™, 5.38 Ratio	360008
Kits, Dana 30™/44™, 4.56 Ratio	360009
Kits, Dana 44™/44™, 4.56 Ratio	360010

REAR AXLE KITS

07-18 Wrangler JK	Part N ^o
Dana 44™ Grande 30-Spline	12156
Rubicon, Dana 44™ Grande 32-Spline	12158

Axle Shafts, 07-18 Wrangler JK	Part N ^o
Dana 44™, LH/RH, 30-Spline	21204C
Dana 44™, LH, 32-Spline	21205C
Dana 44™, RH, 32-Spline	21206C



FRONT AXLE KITS

07-18 Wrangler JK	Part N ^o
Dana 30™ 27-Spline Kit	12152
Rubicon, Dana 44™ 30-Spline Kit	12155



**RUGGED
RIDGE**
www.ruggedridge.com

MINIMUM 5 YEAR WARRANTY



JL ELITE TAIL LIGHT GUARD

The Wrangler JL has set itself apart from every Jeep that has come before, with distinctive styling and refinements at every turn. The unique shape and design of the tail lights is one of the most iconic symbols of the JL, and now you can preserve your tail lights while accenting what it is that makes them so special. Rugged Ridge Elite Tail Light Guards encase your light housing inside a cast aluminum shell, keeping them safe from bumps and blows. The Elite Guards ingenious 2-piece design offers protection in every direction, while accenting the lights original shape and trademark character. Cleverly concealed hardware makes the Elite Tail Light Guards appear to be part of the original design, and not an aftermarket afterthought. Each guard is finished with a premium satin black powder coat for an OE quality appearance and a long life. Works with OE LED tail lights only and works with factory blind spot monitoring systems. US Patent 10059251



Wrangler JL

Part Nº

Satin Black

11226.12

JL ELITE TAIL LIGHT GUARD ENCLOSURE

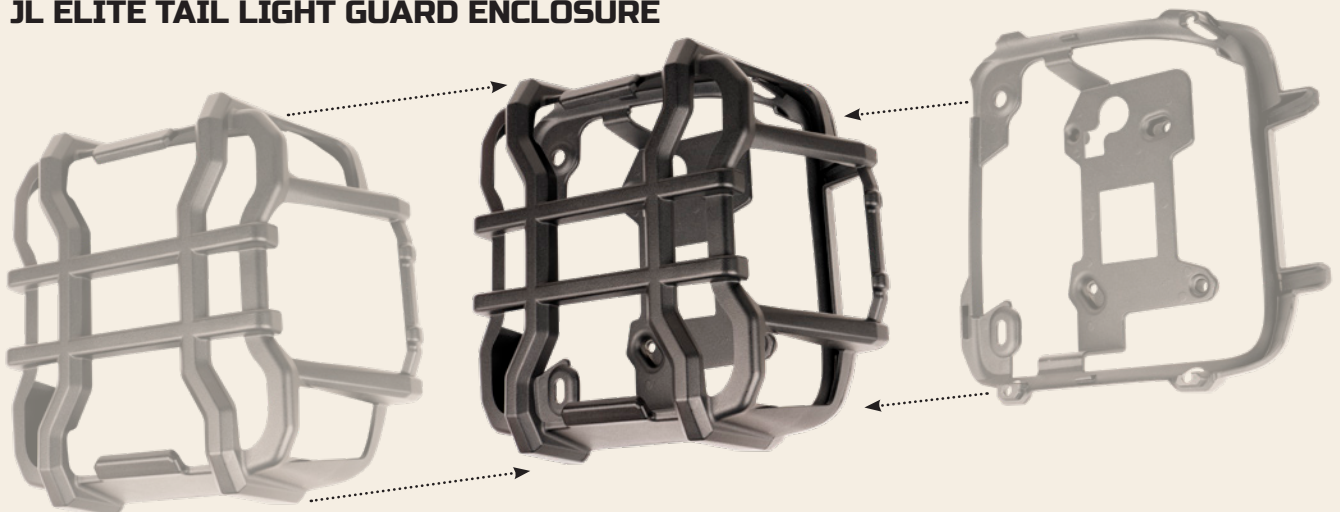



CATALOG# 1251712



OMIX-ADA.COM | RUGGEDRIDGE.COM | ALLOYUSA.COM

460 HORIZON DRIVE SUITE 400 SUWANEE, GA 30024 770-614-6101 INFO@OMIX-ADA.COM

Jeep® is a registered trademark of FCA US LLC, Omix-ADA® is not affiliated with FCA US LLC Part numbers, illustrations and images used for reference purpose only. No implication is made that these are original equipment parts, from those sources whose part numbers are used here for reference or that they are approved by those companies. Omix-ADA®, Rugged Ridge®, Outland Automotive®, Alloy USA® and Precision Gear® names and logos are registered trademarks of Omix-ADA, Inc.®